



CARAVANS 2019

ONTOUR | DE LUXE | DE LUXE EDITION | EXCELLENT | PRESTIGE | PREMIUM

Hobby
BUILT FOR LIFE

PRIZED. TREASURED. BUILT FOR LIFE.

It all started with a groundbreaking idea: to make mobile holidays easier, more comfortable and more relaxing. As a result, Hobby laid the foundations for modern caravans and motorhomes over 50 years ago. This aim is what still drives us to this very day.

We employ over 1,250 members of staff at our site near Rendsburg in Schleswig-Holstein. Over 15,000 vehicles are produced here each year using state-of-the-art machinery in one of the caravan and motorhome industry's largest production sites in Europe.

Our recipe for success is based on four ingredients: trendsetting inventions, innovative technology, modern design and genuine passion. These key foundations have made us the global leader in caravan construction.

Each new generation of vehicles is notable for its superb standard equipment, spacious design, quality and functionality – and each provides premium value at an exceptional price. It's really no wonder that Hobby became the most popular and best-selling caravan brand in Europe.

Hobby. Built for Life.





HOBBY. BUILT FOR LIFE.





HOBBY CARAVAN FACTORY



HOBBY MOTORHOME FACTORY

CONTENTS

2	Hobby. Built for Life
5	Contents
6	Model ranges
62	HobbyComplete All-Inclusive
64	Living area
68	Kitchen
72	Sleeping area
76	Bathroom
80	Body technology
86	On-board technology
90	Optional extras
97	Upholstery combinations
98	Model overview



ONTOUR 6



DE LUXE 14



DE LUXE EDITION 24



EXCELLENT 32



PRESTIGE 42



PREMIUM 54



ONTOUR

THE ENTRY LEVEL ONE





ONTOUR THE ENTRY LEVEL ONE

Lightness is everything with the new Hobby ONTOUR. No unnecessary weight – but everything that's important to you. The ONTOUR is always ready for a spontaneous trip into the wide blue yonder. Less is more: starting at 1,200 kg and 2.20 m wide, the compact Hobby ONTOUR is the perfect caravan however small your towing vehicle. For maximum comfort, choose the layout most suited to your needs from the four different options available.







470 UL



460 DL



390 SF



390 SF







470 KMF



460 DL



470 KMF



390 SF



L: 5,777 mm · B: 2,200 mm · G: 1,200 kg

460 DL

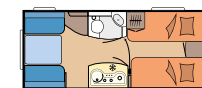

L: 6,602 mm · B: 2,200 mm · G: 1,300 kg

470 KMF

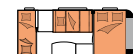

L: 6,706 mm · B: 2,200 mm · G: 1,350 kg

470 UL



L: 6,706 mm · B: 2,200 mm · G: 1,350 kg





DE LUXE

THE FAMILY-FRIENDLY ONE



DE LUXE THE FAMILY-FRIENDLY ONE

For us, true freedom is living in a Hobby caravan. What lies behind the façade? A bright, welcoming home wherever you are in the world – and just a car's length away. So flexible that anything is possible. Breathing space for the modern holidaymaker: the family-friendly DE LUXE comes in 13 versions with five different child bunk layouts. Because true freedom knows no compromises.







560 KMFe



515 UHK



560 KMFe



515 UHK











400 SFe

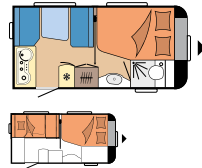

L: 5,961 mm · B: 2,300 mm · G: 1,300 kg

455 UF

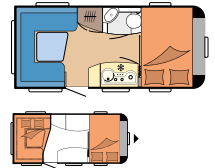

L: 6,476 mm · B: 2,300 mm · G: 1,350 kg

460 UFe

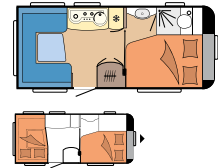

L: 6,626 mm · B: 2,300 mm · G: 1,350 kg

460 LU

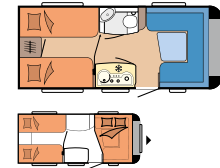

L: 6,748 mm · B: 2,300 mm · G: 1,350 kg

490 KMF

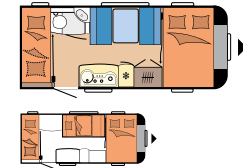

L: 6,885 mm · B: 2,300 mm · G: 1,400 kg

495 UL

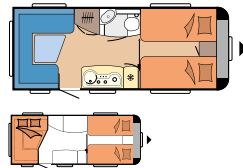

L: 7,124 mm · B: 2,300 mm · G: 1,500 kg

495 WFB

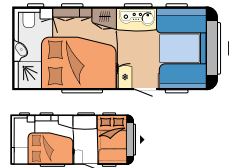

L: 7,124 mm · B: 2,300 mm · G: 1,500 kg

515 UHK

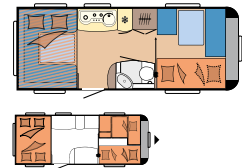

L: 7,530 mm · B: 2,300 mm · G: 1,600 kg

515 UHL

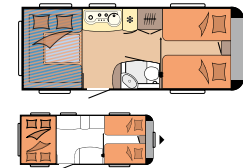

L: 7,530 mm · B: 2,300 mm · G: 1,600 kg

540 UL

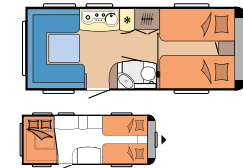

L: 7,290 mm · B: 2,300 mm · G: 1,500 kg

540 KMFe

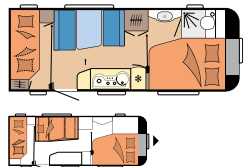

L: 7,442 mm · B: 2,300 mm · G: 1,600 kg

545 KMF

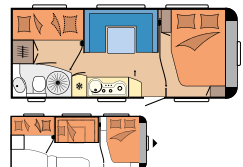

L: 7,422 mm · B: 2,500 mm · G: 1,600 kg

560 KMFe

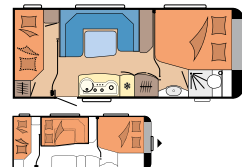

L: 7,510 mm · B: 2,500 mm · G: 1,700 kg





DE LUXE EDITION

THE SPORTY ONE



DE LUXE EDITION THE SPORTY ONE

A sporty design with distinctively clear lines. A young atmosphere with light furniture fronts and subtle red accents. Effective lighting that combines functionality with ambience. The DE LUXE EDITION appeals with its sporty, dynamic lines. A self-contained caravan with character. Featuring compact layouts for couples travelling alone. Or practical designs for leisure-loving families.







545 KMF



650 KMFe



28

545 KMF



495 UL



490 KMF







460 LU



440 SF

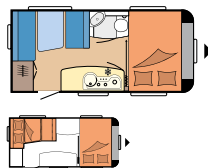

L: 6,137 mm · B: 2,300 mm · G: 1,300 kg

460 UFe

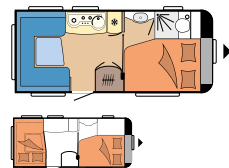

L: 6,626 mm · B: 2,300 mm · G: 1,350 kg

460 LU

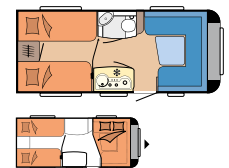

L: 6,748 mm · B: 2,300 mm · G: 1,350 kg

490 KMf

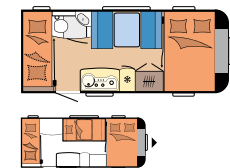

L: 6,885 mm · B: 2,300 mm · G: 1,400 kg

495 UL

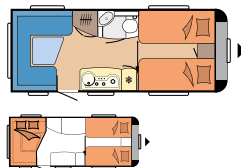

L: 7,124 mm · B: 2,300 mm · G: 1,500 kg

545 KMf

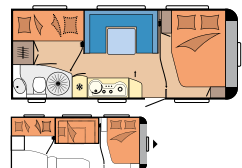

L: 7,422 mm · B: 2,500 mm · G: 1,600 kg

560 KMFe

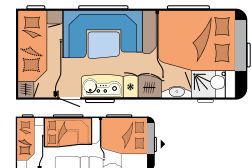

L: 7,510 mm · B: 2,500 mm · G: 1,700 kg

650 KMFe

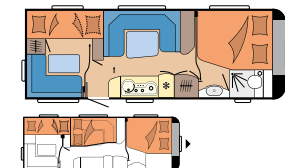

L: 8,322 mm · B: 2,500 mm · G: 1,900 kg





EXCELLENT

THE ELEGANT ONE



EXCELLENT THE ELEGANT ONE

Enjoy life as a couple. Discover idyllic places. And follow your own rhythm. The Hobby EXCELLENT is every couple's dream. Perhaps because of its range of mod cons. Or its spacious design with 13 different layouts. Or its modern exterior. Or its atmospheric ambient lighting for those romantic moments. No wonder the Hobby EXCELLENT is our most popular range.





Hobby

Handwritten notes in a spiral notebook on the table.

EXCELLENT







460 SFf



495 UFe



38

460 SFf









460 UFe

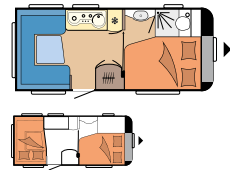

L: 6,626 mm · B: 2,300 mm · G: 1,350 kg

460 SFF

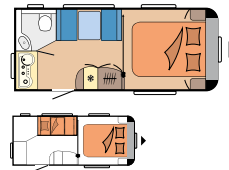

L: 6,748 mm · B: 2,300 mm · G: 1,350 kg

495 UFe

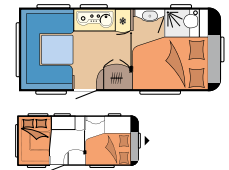

L: 6,767 mm · B: 2,300 mm · G: 1,500 kg

495 UL

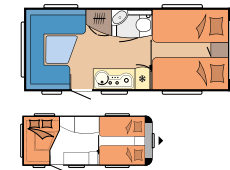

L: 7,124 mm · B: 2,300 mm · G: 1,500 kg

495 WFB

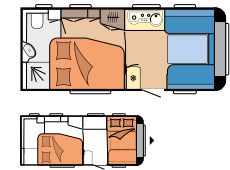

L: 7,124 mm · B: 2,300 mm · G: 1,500 kg

540 FU

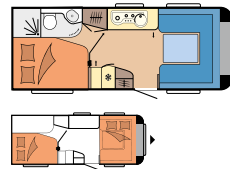

L: 7,271 mm · B: 2,300 mm · G: 1,500 kg

540 WLU

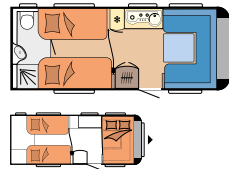

L: 7,271 mm · B: 2,300 mm · G: 1,500 kg

540 UL

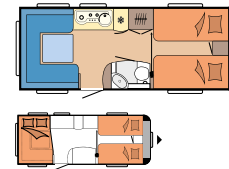

L: 7,290 mm · B: 2,300 mm · G: 1,500 kg

540 UFF

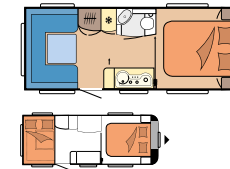

L: 7,342 mm · B: 2,300 mm · G: 1,500 kg

560 CFe

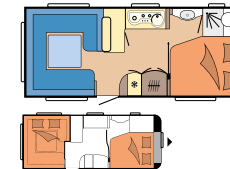

L: 7,510 mm · B: 2,500 mm · G: 1,600 kg

560 KMFe

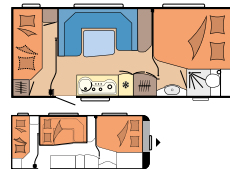

L: 7,510 mm · B: 2,500 mm · G: 1,700 kg

560 LU

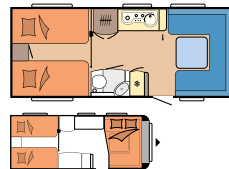

L: 7,510 mm · B: 2,500 mm · G: 1,600 kg

560 WFU

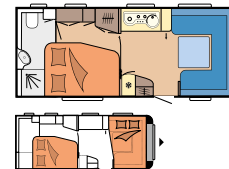

L: 7,558 mm · B: 2,500 mm · G: 1,600 kg





PRESTIGE

THE SUBLIME ONE



PRESTIGE THE SUBLIME ONE

Now you can make your dreams come true! With the Hobby PRESTIGE, even large families can enjoy the luxury of a real home from home wherever they are bound. It is a stylish classic with a special charm. And a sophisticated ambience designed to suit your taste. Twelve different layouts provide plenty of space to move around, and some have special seating areas for the little ones. What more could you want in a caravan?







720 KWFU



46

560 LU



720 UKFe









720 WLC



720 WLC



50

560 WLU







495 UL

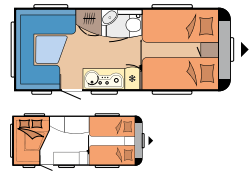

L: 7,127 mm · B: 2,300 mm · G: 1,500 kg

540 FU

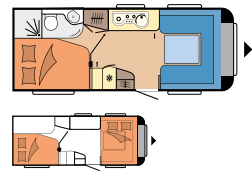

L: 7,274 mm · B: 2,300 mm · G: 1,500 kg

560 LU

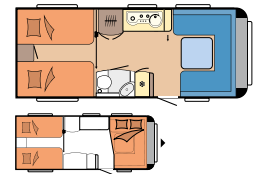

L: 7,513 mm · B: 2,500 mm · G: 1,600 kg

560 WLU

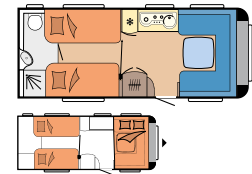

L: 7,513 mm · B: 2,500 mm · G: 1,600 kg

560 WFU

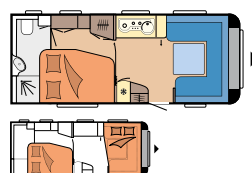

L: 7,561 mm · B: 2,500 mm · G: 1,600 kg

620 CL

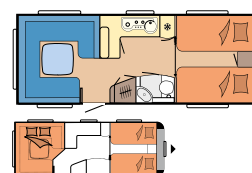

L: 8,025 mm · B: 2,500 mm · G: 1,900 kg

650 UMFe

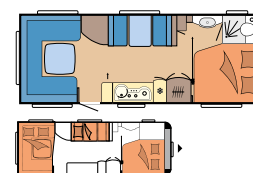

L: 8,325 mm · B: 2,500 mm · G: 1,900 kg

650 KFU

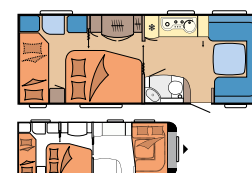

L: 8,375 mm · B: 2,500 mm · G: 1,900 kg

660 WFC

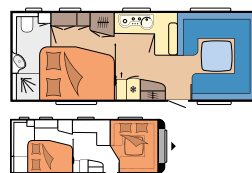

L: 8,325 mm · B: 2,500 mm · G: 1,900 kg

720 UKFe

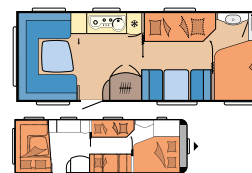

L: 9,030 mm · B: 2,500 mm · G: 2,200 kg

720 KWFU



L: 9,042 mm · B: 2,500 mm · G: 2,200 kg

720 WLC

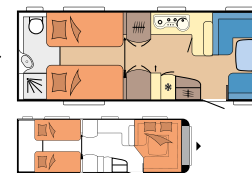

L: 9,042 mm · B: 2,500 mm · G: 2,200 kg





PREMIUM

THE INIMITABLE ONE



PREMIUM THE INIMITABLE ONE

Welcome to the luxury class! For our prize-winning Hobby PREMIUM, only the best is good enough. Elegant throughout – from the exterior design down to the smallest detail. No other caravan has changed the design of the industry as dramatically as the PREMIUM. Six layouts ensure perfect space organisation, whatever your needs, making this van the number-one choice for all those who will only settle for the best.







560 UL



560 CFe



58

560 CFe







495 UL

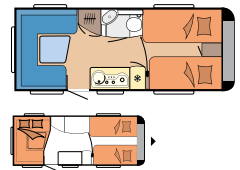

L: 7,630 mm · B: 2,300 mm · G: 1,700 kg

560 CFe



L: 8,016 mm · B: 2,500 mm · G: 1,800 kg

560 UL

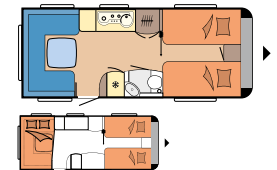

L: 8,016 mm · B: 2,500 mm · G: 1,800 kg

650 UFF

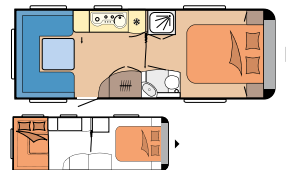

L: 8,828 mm · B: 2,500 mm · G: 2,000 kg

650 UKFe

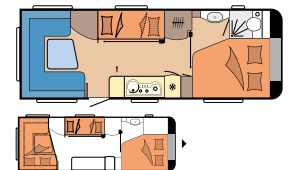

L: 8,879 mm · B: 2,500 mm · G: 2,000 kg

660 WFU

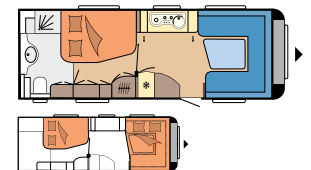

L: 8,865 mm · B: 2,500 mm · G: 2,000 kg

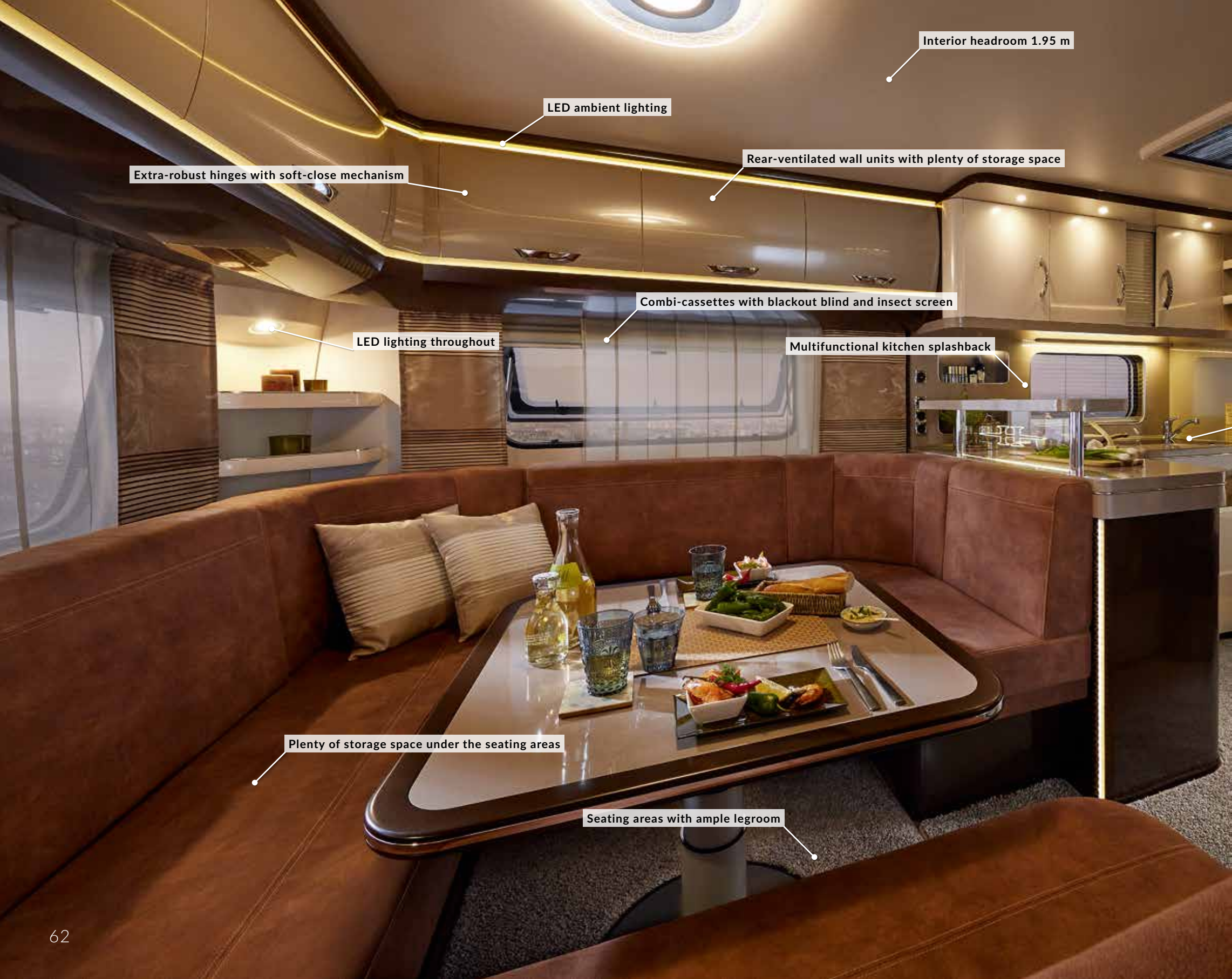

Interior headroom 1.95 m

LED ambient lighting

Extra-robust hinges with soft-close mechanism

Rear-ventilated wall units with plenty of storage space

LED lighting throughout

Combi-cassettes with blackout blind and insect screen

Multifunctional kitchen splashback

Plenty of storage space under the seating areas

Seating areas with ample legroom



DOMETIC SEITZ Midi-Heki rooflight

150-litre Super Slim Tower refrigerator

Luxury hob/sink combination

Comfortable sprung mattresses

Conveniently sized drawers with soft-close and push lock mechanisms

“HOBBYCOMPLETE” YOUR FULLY EQUIPPED HOBBY.

High expectations? Then you've come to the right place! Because with Hobby caravans, modern comforts come as standard.

Items you would pay for elsewhere as optional extras are all part of the package at Hobby. On the following pages you'll find an array of features to make holidays in your Hobby caravan even more enjoyable.



LIVING AREA

A MODERN AMBIENCE TO RELAX IN

SEATING AREA OVERVIEW



CENTRAL SEATING AREA

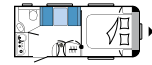

CENTRAL SEATING AREA (DINETTE)



SIDE SEATING AREA (DINETTE)



CHILDREN'S SEATING AREA

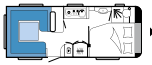

COUCH SEATING AREA



U-SHAPED SEATING AREA



FRONT SEATING AREA



FRONT SEATING AREA (DINETTE)



HEATED COAT RACK

You can hang damp coats and jackets up to dry on the rack by the entrance thanks to warm air vents below. (Depending on model)



TV UNIT WITH GLASS CABINET

The TV unit in the entrance area features a stylish glass cabinet with LED ambient lighting. (Depending on model)



LARGE WARDROBE

The on-board technology systems – comprising heating (depending on model), power supply with transformer and ground fault circuit breaker, two power sockets and antenna connection – are readily accessible inside the spacious wardrobe.



WALL CUPBOARDS WITH VENTILATION BOARDS AND PLENTY OF SPACE

The ventilation boards at the rear of the cupboards ensure optimal circulation of the rising warm air from the heating system. The space between the board and exterior wall prevents cold spots and mildew.



LED WARDROBE LIGHTING

The inside light in the wardrobe is automatically switched on when the door is opened and provides bright light for an optimal overview. It can also be removed for use as a torch.

DOOR HINGES WITH SOFT-CLOSE MECHANISMS

The extremely sturdy hinges ensure that furniture doors close slowly and quietly. The high level of opening and locking force prevents unintended opening while on the road. The doors open up wide towards the ceiling, leaving plenty of headroom.

ILLUMINATED CORNER SHELF

The reflective and illuminated corner panels of the U-shaped seating areas create a special ambience. (Depending on model)



THREE-COLOUR READING LIGHT

Whether you want ambient lighting, a white reading light or twilight lighting – the three-colour reading light lets you create your very own lighting mood. (Depending on model)



STYLISH SET OF GLASSES

An exclusive set of stylish glasses is included on board. (Depending on model)

SWAN NECK LAMPS

The flexible swan neck lamps in the seating areas and by the beds are ideal for reading thanks to their directable light source. (Depending on model)



SEATING AREA WITH AMPLE LEGROOM

The seating areas with slightly offset storage compartments offer optimal legroom. The continuous soft trim means there are no hard edges.

COMBI-CASSETTE WITH BLACKOUT BLIND AND INSECT SCREEN

All sides of the windows are equipped with combi-cassette blinds to protect against sun and insects. (Excluding washroom window)



STEPLESSLY ADJUSTABLE SINGLE-POST LIFT TABLE

The steplessly adjustable single-post lift table allows easy access to the seating area and offers extra legroom. (Depending on model)



KITCHEN

A MARVEL OF COMPACT DESIGN - RIGHT DOWN TO THE LAST DETAIL

KITCHEN OVERVIEW



ROOMY CORNER KITCHEN



EXTRA-WIDE SIDE KITCHEN

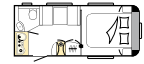

REAR KITCHEN

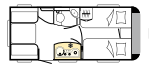

COMPACT SIDE KITCHEN



COMPACT SIDE KITCHEN



EXTRA-WIDE SIDE KITCHEN WITH PLENTY OF STORAGE SPACE



150-LITRE COMPACT SUPER SLIM TOWER REFRIGERATOR

The 38 cm slimline absorption refrigerator developed by Hobby runs silently and has more capacity and power while taking up less space. Thanks to the Super Slim Tower design, the refrigerator door no longer protrudes as far into the room and the contents are kept even more securely in place.



Seven height-adjustable compartments in the door mean you can now store taller 1.5-litre bottles as well as 1-litre bottles and Tetra Paks. The large 15-litre freezer compartment is removable.

PRACTICAL HOB/SINK COMBINATION WITH EXTRA WORKSPACE

The gas hob and sink are made from robust stainless steel and form a continuous unit for easier cleaning. The generous space between the three burners makes preparing meals easy, even with bigger pans. The hob comes with electric ignition, and the split safety glass cover can be used to provide additional workspace if required.



CONVENIENTLY SIZED DRAWERS WITH SOFT-CLOSE AND PUSH LOCK MECHANISMS

The extra-large drawers provide space for all kinds of utensils, and can be fully extended for a good overview and easy access. The soft-close mechanism ensures smooth, quiet closure, with secure locking thanks to the push lock system. Reinforced support struts and longer strike plates keep fully loaded drawers firmly in place even while on the move.

TOWEL RAIL

In many kitchens, a pull-out towel rail provides a space for tea towels. (Depending on model)



SPICE RACK

Depending on the model, the kitchen wall units come with handy spice racks so you can keep salt, pepper and herbs to hand.



PRACTICAL CUTLERY INSERT

Cutlery drawers with well-planned dividers prevent cutlery and kitchen utensils from getting mixed up in transit.

STORAGE BASKET UNITS WITH PULL-OUT DRAWER

The storage basket units with pull-out drawers can be fully extended so that not a centimetre of space is wasted. (Depending on model)



KITCHEN WINDOW WITH BUILT-IN POWER SOCKETS

The combi-cassette with blackout blind and insect screen has a bright LED kitchen light and two handy placed sockets. (Depending on model)



MULTIFUNCTIONAL KITCHEN SPLASHBACK

The kitchen splashback with the large window and the combi-cassette featuring a fully integrated blackout blind and pleated insect screen is a beautiful, all-in-one unit. A USB charger socket and 230 V power sockets are also perfectly integrated into the kitchen splashback. (Depending on model)



ROOMY CORNER BASE CABINET

The large swivelling pull-out unit of the kitchen base cabinet accommodates pots and pans, making optimal use of the available storage space. (Depending on model)



ELEGANT KITCHEN COUNTER

The modern worktop gives the kitchen a very sophisticated look. Its transparent panel with the distinctive Hobby logo is a real design highlight. The work surface with its handy shelf also functions as an elegant partition between the seating and kitchen areas.



SLEEPING AREA

FOR A SNUG AND RESTFUL NIGHT'S SLEEP

SLEEPING AREA OVERVIEW



DOUBLE BED



DOUBLE BED - TRANSVERSE



COMFY SINGLE BEDS



EASY-ACCESS QUEEN-SIZED BED



CHILDREN'S BEDS

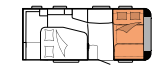

FRONT SEATING AREA CONVERTED TO LARGE SLEEPING SPACE



SEVEN COMFORTABLE BERTHS

The De Luxe 515 UHK features a total of seven berths. After converting the seating area and letting down the drop-down bed, two comfortable double beds are available in the rear. Three further berths are located in the children's compartment.



VARIABLE DROP-DOWN BED

Thanks to the robust cable pull mechanism, the drop-down bed can be lowered into any position and fixed in place beneath the roof together with all of its accoutrements.



SPACIOUS CHILDREN'S ROOM

In addition to the fixed bunk bed with two berths, an additional place to sleep is created in the De Luxe 515 UHK by converting the side seating area.

CHILD-FRIENDLY TEDDY-BEAR LIGHT

Turn the nose of the bear to dim the light – perfect for sending little campers off to sleep. (Depending on model)



COMFY SPRUNG MATTRESS

All fixed beds are equipped with sprung mattresses and sturdy laminated beechwood bed frames.

CHILDREN'S BUNK BEDS WITH COLOURING BOARD

During the day, the bottom bunk bed can be folded up to provide a space to play in – with the underside of the bed acting as a wipe-clean board. (Depending on model)



For a safe night's sleep, the top bunk is fitted with a safety rail to prevent you from falling out.

COMFY HEADBOARD

The upholstered panel made of easy-to-clean artificial leather at the head of the bed ensures a clean finish, the LED swan neck lamps give you a pinpoint reading light, and the wide shelves provide you with plenty of space to store books, glasses, clocks and many other personal items.



EASY-ACTION BED LIFT

Many of the bed frames are fitted with opening aids. This takes the form of a gas spring (Lift-O-Mat) in Queen-size and double beds and a spring mechanism in single beds.

ELEGANTLY DESIGNED FRONT WINDOW WITH PRACTICAL DETAILS

More light, more air, more practicality. The sturdy front window has a fully integrated combi-cassette with pleated blackout blind and insect screen and comes complete with shelves for books and other items. (Depending on model)



CENTRAL LIGHT SWITCH AND POWER SOCKETS IN SLEEPING AREA

The bed has an extra built-in light switch for easy access, and a power socket is provided in the sleeping area for added convenience. (Depending on model)



WASHROOM

EVERYTHING YOU NEED FOR PERSONAL CARE

WASHROOM OVERVIEW



LARGE REAR WASHROOM WITH SEPARATE SHOWER AND PLENTY OF STORAGE SPACE



COMPACT WASHROOM WITH SINK AND TOILET



COMPACT WASHROOM WITH SEPARATE SHOWER



WASHROOM WITH EXTERNAL WASHBASIN



DESIGNER SHOWER

This new shower cubicle is a real bathers paradise. It provides you with plenty of room to move around in and the highest levels of sanitary comfort. With its stylish designer shower column and the bright ceiling spotlight, it's also impressive in terms of its appearance and functionality. (Depending on model)



GENEROUS STORAGE FACILITIES

All care products can be readily accommodated in the under-sink cupboard and mirror cabinets in the washrooms. (Model examples)



SPACIOUS TOILET AT THE FRONT

The WC has lots of space to move around in. Opaque side windows guarantee optimal ventilation. (Depending on model)



EXCLUSIVE THETFORD CASSETTE TOILET

Toilets developed exclusively for Hobby with all-round sealing lip and smooth surface for easy cleaning. (Depending on model)

ROOFLIGHTS

Lets light in and moisture out! Many bathrooms are equipped with full-sized rooflights, e.g. Mini-Heki from DOMETIC SEITZ. (Mini-Heki depending on model)



HIGH-QUALITY WASHBASIN FITTINGS

The tap blends in perfectly with the modern bathroom design.



PRACTICAL THETFORD ROTATING TOILET

The cassette toilet can be rotated by 2 x 90 degrees, ensuring optimal use of space. (Depending on model)



HIGH-QUALITY DESIGNER DOOR HANDLE

The washroom doors are equipped with an ergonomically designed metal door handle. The improved shape helps prevent loose clothing from getting caught on it.



TOOTHBRUSH HOLDERS INCLUDED

Two toothbrush holders complete the luxury washroom package. (Depending on model)



BODY TECHNOLOGY

STRONG INNOVATION AND TECHNOLOGICAL FINESSE

STATE-OF-THE-ART BODY TECHNOLOGY

BRIGHT EXTERIOR LIGHTING

Long-lasting and reliable lights (mostly LED-technology) ensure that your caravan is always visible. They are harmoniously integrated into the contours of the vehicle, thereby emphasising its distinctly automotive design. The third brake light is a decisive safety advantage.



The bright LED awning light illuminates the doorway and provides a pleasant light in the awning.

USER-FRIENDLY LOCKING SYSTEM

One key for everything: entrance door, fresh water tank, gas locker, storage locker indicator, boot lids and toilet cassette removal door.



OVERRUN BRAKE BY KNOTT WITH AUTOMATIC ADJUSTMENT

The KNOTT ANS overrun brake adjusts itself automatically, guaranteeing unrestricted braking performance at all times. A key safety feature, particularly in critical driving conditions.

JOCKEY WHEEL WITH LOAD INDICATOR

The safety jockey wheel with integrated load scale is included as standard in many models. (Depending on model)



WINTERHOFF STABILISER HITCH

Easy coupling – safe arrival: the WINTERHOFF WS 3000 safety coupling with tracking stabiliser and unrivalled single-lever system is all part of the package with Hobby.

STREAMLINED GRAB HANDLE

In virtually all Hobby caravans, owners and their guests are greeted by an ergonomically shaped grab handle that's a real eye-catcher with its gleaming chrome and exclusive Hobby logo. (Depending on model)



A FRAME WITH STAND-ON COVER

The A Frame is tailored to the respective chassis for improved driving performance. The A Frame cover forms a visual unit with the towing device.

EXTRA-WIDE ENTRANCE DOOR WITH WINDOW, TRIPLE-POINT LOCKING, CONCEALED HINGES, STORAGE SHELVES AND WASTE BIN

The extra-wide, one-piece entrance door with concealed inside hinges impresses not just with its generous dimensions but also its appealing design and thoughtful details. The large integrated window lets plenty of light into the caravan interior and forms an elegant unit with the frame.



The inside of the door is equipped with handy shelves, a waste bin and a pleated insect screen. The practical waste bin with integrated dustpan and brush helps you to keep the vehicle clean. Another notable feature of the Hobby door, which is 40 mm wider than standard doors, is the highly effective splash water seal.

HIGH-QUALITY VENT WINDOWS

The double-glazed, tinted vent windows with safety locks are specially moulded, which – together with the thicker material – makes them much more resistant to stresses and deformation (especially heat and cold). Another positive effect is the improved sound insulation, while a new sealing system provides long-lasting protection against the ingress of moisture.



WHEEL COVERS AND AIR PRESSURE DISPLAY

The standard wheel trims in white are optimally designed to match your caravan. The pressure display on the wheel arch spat indicates the required tyre pressure. An integrated rubber clamping lip provides a visually elegant wheel covering solution. (Draught skirt not included)

FRONT BODY TECHNOLOGY

The well-designed front section is dominated by a solid corner structure made from a moulded PU frame. The sandwich construction with EPS core and the sturdy windowsill in PE foam above the gas locker ensure maximum heat insulation. PU-foamed corner posts join the front firmly to the sidewall and have good insulating properties as well as being water-resistant. They provide a secure connection for the ABS mouldings, giving rise to the unique exterior design of Hobby caravans with their streamlined rounded edges. (Ontour, De Luxe, De Luxe Edition, Excellent, Prestige)



INSULATED ROOFLIGHTS FROM DOMETIC SEITZ

Every Hobby caravan is fitted with a DOMETIC SEITZ Midi-Heki rooflight. Up to two additional Mini-Heki roof vents help to ensure optimal ventilation.



SHINY REAR BUMPER TRIM

The Chrome coloured trim positioned above the number plate on the De Luxe, Excellent and Prestige caravans is a real eye-catching feature.

TAILORED BODY JOINTS

The aerodynamic lines without corners or edges are typical of Hobby caravans. All body joints have sealed frame profiles. This ensures a seamless, harmonious design and prevents moisture from getting in.



ULTRA-STURDY MANOEUVRING HANDLES

The grab handles on your Hobby caravan are ergonomically shaped and an integral part of the structure. They are integrated harmoniously into the exterior design of the vehicle. In the De Luxe Edition, Excellent and Prestige, the chrome look sets off the vehicle design to perfection.



ELEGANT MANOEUVRING HANDLE

The grab handle integrated in the rear light of the Premium has been seamlessly adapted to its curved rear section. Thanks to the flowing transitions, everything looks to be made from one piece.

AWNING RAIL RAIN DEFLECTOR

The awning rails on the front and rear with specially moulded end pieces ensure even better rainwater drainage.



FRONT SPOILER CRANK HOLES

The heavy-duty corner steadies are easily reached via the openings in the skirt rail.

ROOMY GAS LOCKER

The gas lockers not only hold two 11 kg gas bottles, but also have space for the Corner steady winding handle, wheel chocks and waste water tank. Easy access is ensured by solid, vertically opening parallelogram fittings. The plastic floor is rot-proof and easy to clean.



PREMIUM GAS LOCKER

The gas locker has a low sill and sturdy aluminium chequer-plate floor and provides space for the chocks, corner steady winding handle and waste tank.. The gas regulator with over-pressure protection is easily accessible, and there are sturdy holding devices for two 11-kilogram gas bottles. (Premium)

PRACTICAL BOOT

The boot in the back of the vehicle is ideal for stowing camping tables and chairs, for example. Double locking and an all-round rubber sealing lip protect against splash water. (Premium)





ON-BOARD TECHNOLOGY

FOR A HOLIDAY WITHOUT COMPROMISES

ON-BOARD TECHNOLOGY

LED AMBIENT LIGHTING

An array of lighting elements using energy-saving LED technology serve to create a unique atmosphere. The LED strip lights on the wall units provide an extra-special touch (optional in the Ontour and De Luxe). All 12V lighting consists exclusively of energy-saving LED technology.



TOUCH-CONTROL LIGHT SWITCHES

The separate light switches come with a touch-control mechanism for easier operation.



LIGHT CONTROL SYSTEM WITH BASIC CONTROL PANEL

The light control system with CI-BUS technology is located in the entrance area of all Hobby caravans. It controls nearly all the lighting units, displays the fresh water level and regulates the hot water heating unit and optionally available underfloor heating. (Example model)



CHILDREN'S LIGHT SWITCHES

Easily reached by little campers: the light switch at child-friendly level.

TRUMA BOILER

The tried-and-tested 5-litre TRUMA (therme) water heater uses the warmth from the heater to heat the water. It also has an electric heating element which comes into play when the heating is turned off.



TRUMA COMBINATION HOT AIR HEATING SYSTEM WITH HOT WATER BOILER

The hot air pipes of the TRUMA combi heater ensure an optimal distribution of heated air throughout the vehicle for a cosy temperature. It is controlled via the Hobby TFT control panel and also via the digital CP PLUS TRUMA control panel in the sleeping area.



SAFETY GAS REGULATOR

The flexible connecting tube with gas regulator and integrated over-pressure valve according to DIN EN 12864 fits all common gas bottles.



CENTRAL GAS DISTRIBUTOR IN KITCHEN

The gas distributor is located in an easily accessible spot in the kitchen.



TRUMA HEATER S 3004 / S 5004

The powerful fan with booster function on the standard TRUMA heater is a quick, effective and eco-friendly way of warming up the caravan. (Depending on model)



CENTRALLY INSTALLED ON-BOARD TECHNOLOGY

The on-board technology systems – comprising heating, power supply with transformer and ground fault circuit breaker, two power sockets and antenna connection – are readily accessible inside the spacious wardrobe. (Example)



WATER AND POWER CONNECTIONS

A standard outdoor socket is provided for connecting the caravan to the power supply. The awning socket with SAT/TV connection allows you to connect 230 volt devices (optional in the Ontour, De Luxe and De Luxe Edition). The water connection lets you fill the water tank easily with a hose. All outside connectors have pictograms to make their functions clear.



POWER SOCKETS WITH TV CONNECTION

At least five 230 V power sockets are installed in every Hobby caravan as standard, along with a coaxial cable kit including a socket for the TV connection. (3 pin sockets in UK supplied caravans)



PASSENGER VEHICLE CONNECTOR

The standard 13-pin passenger vehicle connector from Jaeger not only supplies the brake and rear lights with power, but also allows all the caravan's 12 V system to run off the car battery.

STORAGE SPACE UNDER SEATING AREAS

The seating areas have an easily accessible storage compartment for all your important travel accessories. (Depending on model)



LARGE FRESH WATER TANK

The fresh water tank, which can be filled from the outside, is located in an easily accessible spot under one of the seat bases or bed lockers. A large scrow off cap allows easy cleaning. (Pictured here is the 50-litre fresh water tank)



EASY DISPOSAL

The service hatches for the cassette toilets are located on the left-hand side of the caravan on the majority of models featuring a double bed. This makes it easier to empty the cassette toilets, and this task no longer has to be done through the awning.



HobbyConnect

Hobby sound system

12 V autonomy package and state-of-the-art battery management

Articulated TV bracket with swivel arm

Hobby CI-BUS on-board management system with TFT control panel

MyHobby app

Spare wheel with holder

Elegant alloy rims

Underfloor heating

OPTIONAL EXTRAS

Do you have a specialist hobby or specific equipment requirements? The appropriate optional extras and many individual solutions are available to help you tailor your caravan to your own purposes and holiday needs.

SPACIOUS GARAGE

The garage provides space for bulky luggage. (Pictured here is an example model)



ELEGANT AWNING FROM THULE OMNISTOR

Sun and rain protection: THULE OMNISTOR awnings are precisely tailored to the Hobby caravans.



STURDY REAR BICYCLE RACK

The THULE bicycle rack is tailor-made for Hobby caravans. The lockable guide rail prevents the bikes from moving in transit and is fixed in place manually. (Depending on model)



A FRAME DRAWBAR BICYCLE RACK

Bikes can be easily transported on the A frame carrier, which also ensures an even distribution of weight and is easily folded forwards out of the way to give access to the gas locker.



THETFORD SERVICE HATCH WITH CENTRAL LOCKING

Additional service hatches are available for many models.



ELEGANT ALLOY RIMS

The elegant alloy rims add the finishing touch to the caravan's appearance. (Pictured is the black polished version included with the Premium model)



SPARE WHEEL HOLDER

Available for many models: the lightweight spare wheel holder. Placing the spare wheel under the caravan creates more storage space in the gas locker, for example. (Depending on model)

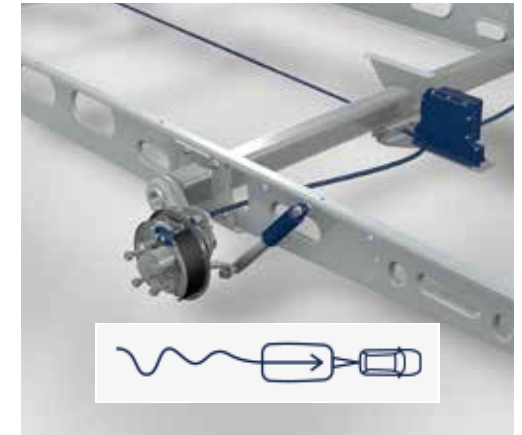

KNOTT ETS PLUS ELECTRONIC STABILISATION SYSTEM

The high-performance sensor monitors the movement of the car and caravan continuously while on the road. ETS Plus counters any snaking movements instantly and effectively and brakes automatically in case of danger.

PULL-OUT BED EXTENSION

For many caravans with single beds, a pull-out bed extension can be supplied as an option. The additional cushion creates an extra-large sleeping space. (Depending on model)



DOUBLE BED WITH ADDITIONAL CHILDREN'S BUNK BED

Instead of single beds, the 620 CL and 560 LU models are also available with a spacious double bed situated across from a children's bunk bed. That provides a welcome solution for families, as it eliminates the need to convert the seating area into a sleeping area. For those travelling with more than four passengers, an impressive total of six sleeping berths are available.

THREE-TIER CHILDREN'S BUNK BED

The sleeping area for children is also optionally available with three beds. (Depending on model)



QUEEN-SIZE BED TRANSVERSE AT THE FRONT

In the Prestige 620 CL, there is the option to replace the single beds in the front area with a transverse queen-size bed. (Image for illustration purposes only)



COLD FOAM MATTRESS

The cold foam mattress with seven different hardness zones offers luxury sleeping comfort.

COMBINED HOB/OVEN INCLUDING GRILL

The new full-sized cooker is available as an option for the Prestige model. With three gas hobs, an electric hotplate, a separate grill and the large oven, there's nothing else even ambitious amateur cooks could wish for. (Standard in all UK Prestige caravans)



OVEN

Now you can bake bread on holiday too – or rustle up some homemade pizza for lunch – thanks to the optionally available built-in 36-litre oven with light. (Installation position depending on model; illustration may vary; Standard in all UK caravans, except Prestige)



DOMETIC EXTRACTOR HOOD

An extractor hood completes the kitchen fittings and keeps cooking smells in check. (Excluding 400 SFe, 460 SFf)



BLACKOUT BLIND ON THE WASHROOM WINDOW

The convenient combi-blinds with a built-in insect screen reliably keep the washroom from heating up too much if the sun shines in. (Depending on model)



SHOWER FITTING IN TOILET

The optional shower fitting turns the washroom into a handy shower. (Standard in all UK caravans with a washroom)



MICROWAVE

Home-from-home convenience: the microwave is ideal for heating up food in a hurry. (Installation position depending on model; illustration may vary; Standard in all UK Prestige and Premium caravans)



REMOVABLE CARPETING

The optional carpeting lets you recreate the comfort of your living room at home. It consists of multiple elements specially tailored to fit the layout of your caravan, and can be easily removed for cleaning. (Standard in all UK caravans except On Tour (optional))



MAINS WATER CONNECTION

Standard water connection with garden hose connector for easy filling of water tank via the mains water supply.



EXTERNAL GAS SOCKET

External connector for gas appliances e.g. BBQ.

HOBBY CI-BUS ON-BOARD MANAGEMENT SYSTEM WITH TFT CONTROL PANEL

The Hobby-designed CI-BUS on-board management system controls all devices and functions within the on-board network. The control button plus six additional softkeys under the display allow convenient and intuitive navigation between menus. Whether TRUMA, ALDE or DOMETIC: thanks to the cross-sector interface, the new symbols and graphics on the Hobby TFT control panel represent a cross-section of all manufacturers' symbols. That way the user is presented with an already familiar symbolic environment and can read off data from the display, e.g. date/time, inside/outside temperature, water tank filling level and battery charge/discharge, or activate settings directly. Other BUS-capable on-board components, such as heating, air conditioning and the electric rooflight can also be centrally controlled. The system is standardised and updateable, thus ensuring compatibility with next-generation devices. To date, up to 15 devices can already communicate with the control panel. (See manufacturer's instructions; Standard in all UK Caravans except On Tour)



12 V AUTONOMY PACKAGE AND STATE-OF-THE-ART BATTERY MANAGEMENT

The intelligent battery sensor (IBS) supplies all the key data such as charging time, charging current and charging voltage, as well as the remaining running time and discharge current of the GEL or AGM battery in autonomous mode. All values can be read off from the TFT control panel. The battery sensors supply the intelligent charger with the exact charging current and voltage it needs, thereby ensuring energy-efficient charging up to 100 percent capacity. With this system, charging times are reduced by approx. 30% by comparison with conventional chargers.

HOBBYCONNECT

Developed exclusively for Hobby leisure vehicles, the HobbyConnect M2M system allows you to control the entire on-board technology via mobile devices such as smartphones or tablets. For this you will need the "MyHobby" app, which can be used to check or directly activate settings such as time, temperatures, filling levels and battery charge. (Standard in UK Prestige and Premium Models)

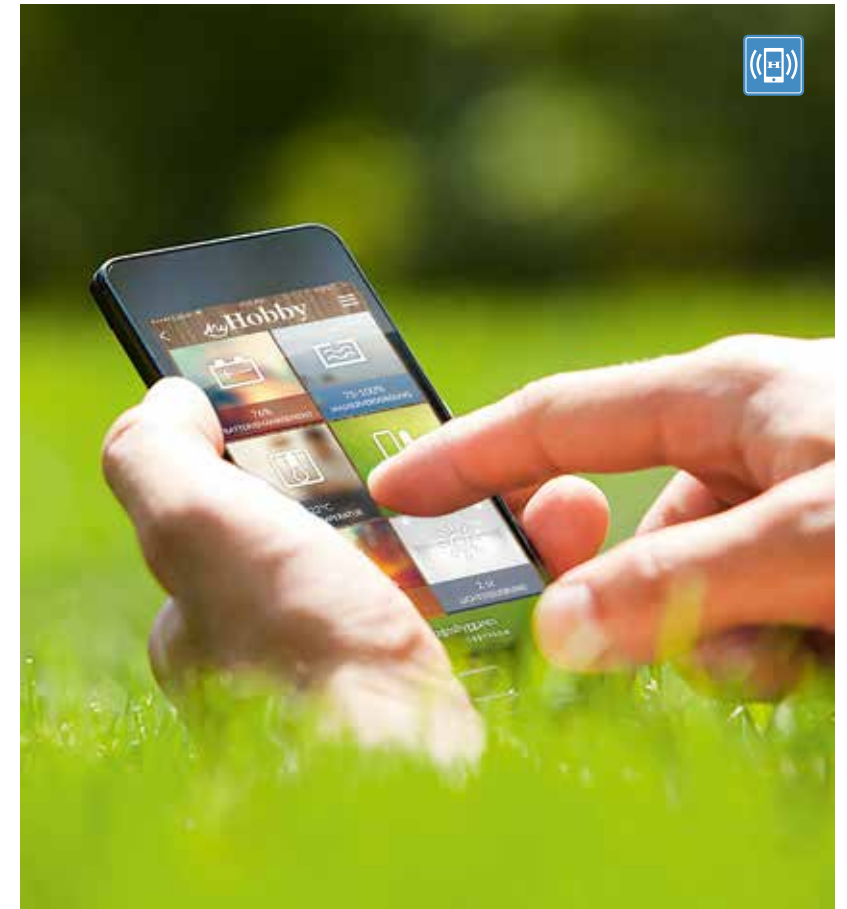

Other BUS-capable on-board components such as heating and air conditioning can also be centrally controlled. HobbyConnect provides an interface between the caravan's CI-BUS on-board management system and the Internet. That means you can connect directly with virtually any location in the world from your own vehicle. Data communication takes place in both directions via a special web server. That way you can receive push notifications on the mobile device, e.g. if the vehicle is removed from its location in case of theft.

ALDE HOT WATER HEATER

The ALDE hot water heater 3020 HE with a total power output of 8,500 watts and an integrated 8.4-litre boiler is available from type 490. Heating and water heating can be activated both simultaneously and independently of one another. (Standard in all UK Premium caravans)



UNDERFLOOR HEATING

All Hobby caravans can be supplied with an electric underfloor heating system. The heating films in the useable part of the floor prevent thermal bridges and cold feet.

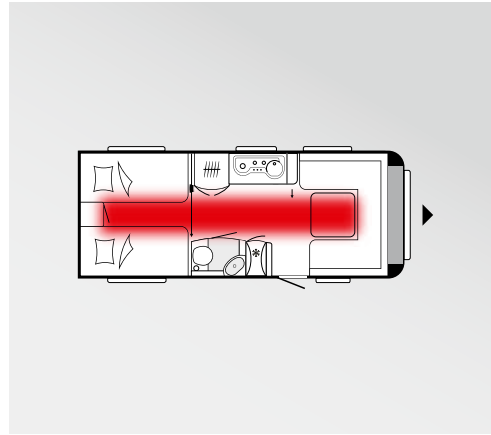

HOT WATER UNDERFLOOR HEATING

The combination of a hot water heater and hot water underfloor heating provides the highest levels of comfort. The floor is warmed up by a system of pipes, through which the hot water flows. In conjunction with heat transfer panels, the heat is distributed throughout the floor of the vehicle.

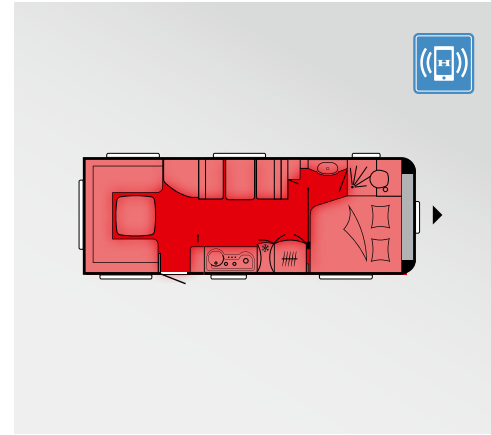

DOMETIC ROOF-MOUNTED AIR-CONDITIONING UNIT FRESHJET WITH HEATING FUNCTION

The roof-mounted air conditioning unit has four controllable air flow settings. This quality light-weight system is economical and pleasantly quiet.



FAST HEATING THANKS TO TRUMA VARIOHEAT

All caravans up to type 495 (standard on 460 Sff) can be fitted with the TRUMA VarioHeat "Comfort". It features three heat settings, warms up the caravan in next to no time, and automatically adjusts the heat output to the required room temperature. As a digital gas heating system, it can be perfectly integrated into the Hobby CI-BUS on-board management system.



TRUMA ELECTRIC BOILER, 14-LITRE

The optionally available high-power heating element heats water from 15 °C to 70 °C in just 70 minutes. Sustained heat storage also ensures extremely short reheating times, thus saving both energy and money.



ADDITIONAL ELECTRIC HEATER

The additional 230V TRUMA Ultraheat electric heater provides a back-up for the TRUMA gas heater and uses the existing hot air pipes. It serves to warm up the interior more quickly on cold days. (Standard in all UK caravans fitted with a Truma S heater: except On Tour.)

SMOKE ALARM

Preventive fire protection while on the road. The compact smoke alarm quickly and reliably alerts you if fire smoke is detected in the vehicle.



SATELLITE SYSTEM

The fully automatic satellite system Cap 650 from Kathrein includes a rotating flat antenna with a large range. Measuring just 21 centimetres high, it has excellent aerodynamic qualities. The antenna comes with a twin LNB, which means that two receivers can be integrated in the system and are automatically aligned.



ARTICULATED TV BRACKET WITH SWIVEL ARM

Optionally available for many models: the swivelling TV bracket for watching TV from the seating area or bed – top-rated by the German specialist magazine “Camping, Cars & Caravans”. A pull-out shelf for the TV is used in vehicles where there is not enough room to fit the articulated bracket.



BLAUPUNKT 4.1 SOUND SYSTEM WITH POWERFUL SUBWOOFER

Versatile entertainment system for listening to the radio and playing music (CD, USB storage stick, SD card) with comfortable operation of all functions via remote control. Excellent audio quality is ensured by four loudspeakers positioned in optimal locations in the living area.



USB CHARGING SOCKET

This optional double socket can be used to charge two mobile devices at the same time. The LED reading lights for the children's beds are also each equipped with an integrated USB charging socket.

UPHOLSTERY OVERVIEW

COMBINATIONS TO SUIT EVERY TASTE

TAIGA

Standard in the Ontour



PATCH

Standard in the De Luxe



AVUS

Standard in the De Luxe Edition



TORINO

Standard in the Excellent



JAVA

Standard in the Prestige



VERMONT

Alternative option as standard in the Premium



KENTUCKY

Alternative option as standard in the Premium



LEATHER FINISH

Optional for Premium

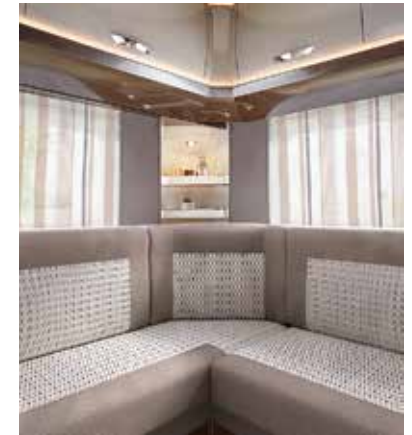

CAPRI

Optional extra for all models

All standard upholstery designs are also available as an option.

DOUBLE BEDS

390 SF  

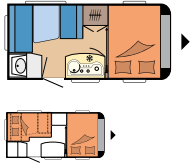

Ontour
L: 5,777 mm · B: 2,200 mm · G: 1,200 kg

400 SFe  

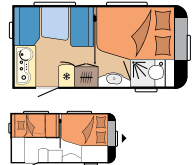

De Luxe
L: 5,961 mm · B: 2,300 mm · G: 1,300 kg

440 SF  

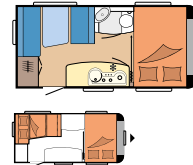

De Luxe Edition
L: 6,137 mm · B: 2,300 mm · G: 1,300 kg

455 UF  

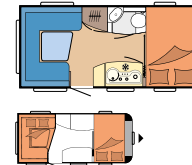

De Luxe
L: 6,476 mm · B: 2,300 mm · G: 1,350 kg

460 UFe  

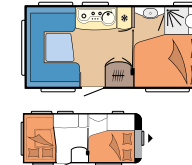

De Luxe, De Luxe Edition, Excellent
L: 6,626 mm · B: 2,300 mm · G: 1,350 kg

495 UFe  

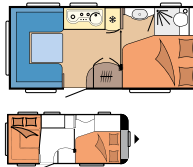

Excellent
L: 6,767 mm · B: 2,300 mm · G: 1,500 kg

495 WFB  

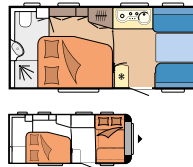

De Luxe, Excellent
L: 7,124 mm · B: 2,300 mm · G: 1,500 kg

540 FU  

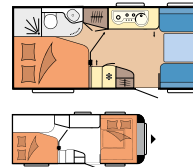

Excellent, Prestige*
L: 7,271 mm · *L: 7,274 mm
B: 2,300 mm · G: 1,500 kg

560 CFe  



Excellent
L: 7,510 mm · B: 2,500 mm · G: 1,600 kg

560 WFU  



Excellent, Prestige*
L: 7,558 mm · *L: 7,561 mm
B: 2,500 mm · G: 1,600 kg

560 CFe  

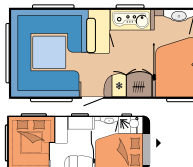

Premium
L: 8,016 mm · B: 2,500 mm · G: 1,800 kg

650 UMFe   

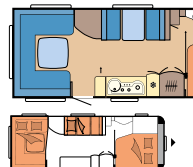

Prestige
L: 8,325 mm · B: 2,500 mm · G: 1,900 kg

660 WFC   



Prestige
L: 8,325 mm · B: 2,500 mm · G: 1,900 kg

660 WFU   



Premium
L: 8,865 mm · B: 2,500 mm · G: 2,000 kg

QUEEN-SIZE BEDS

460 SFf  

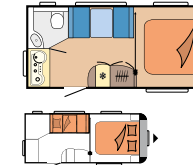

Excellent
L: 6,748 mm · B: 2,300 mm · G: 1,350 kg

540 Uff  

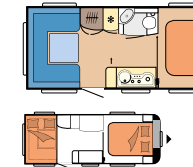





Excellent
L: 7,342 mm · B: 2,300 mm · G: 1,500 kg

650 Uff   



Premium
L: 8,828 mm · B: 2,500 mm · G: 2,000 kg

KEY TO SYMBOLS

	Sleeping area		Berths
	Seating area		Children's berths
	Kitchen		Drop-down bed
	Bathroom		Tandem axle
	Storage space		Refrigerator (litres)

DESIGN

F	Double bed	B	Front seating area
Fe	Double bed, external washroom	C	Couch seating area
Ff	Queen-size bed (free-standing double bed)	D	Dinette
H	Drop-down bed	M	Central seating area
K	Children's beds	S	Side seating area
L	Single beds	U	U-shaped seating area
		W	Rear washroom

TECHNICAL DATA

L	Overall length
B	Overall width
G	Maximum technically permissible laden mass

OPTIONAL LAYOUT CHANGES

Double bed instead of single beds with additional children's bed, multi-tiered (CKF/KFU)



Prestige 620 CL (CKF)
(Optional extras)



Excellent, Prestige 560 LU (KFU)
(Optional extras)

Queen-size bed transverse instead of lengthwise single beds



Prestige 620 CL (Optional extras)

Seating area extension



Excellent 460 SFf (Optional extras)

SINGLE BEDS

460 DL

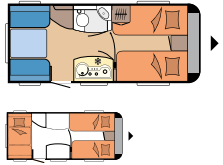

Ontour
L: 6,602 mm · B: 2,200 mm · G: 1,300 kg

460 LU

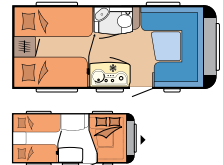

De Luxe, De Luxe Edition
L: 6,748 mm · B: 2,300 mm · G: 1,350 kg

470 UL

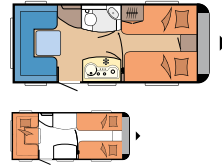

Ontour
L: 6,706 mm · B: 2,200 mm · G: 1,350 kg

495 UL

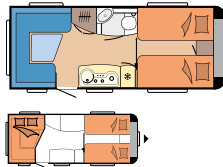

De Luxe, De Luxe Edition, Excellent, Prestige*
L: 7,124 mm · *L: 7,127 mm
B: 2,300 mm · G: 1,500 kg

495 UL

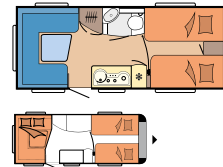

Premium
L: 7,630 mm · B: 2,300 mm · G: 1,700 kg

515 UHL

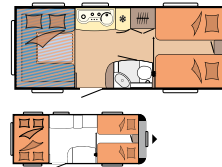

De Luxe
L: 7,530 mm · B: 2,300 mm · G: 1,600 kg

540 WLU

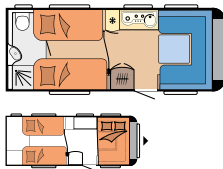

Excellent
L: 7,271 mm · B: 2,300 mm · G: 1,500 kg

540 UL

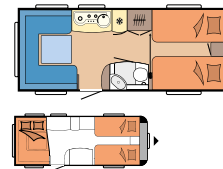

De Luxe, Excellent
L: 7,290 mm · B: 2,300 mm · G: 1,500 kg

560 LU

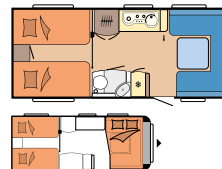

Excellent, Prestige*
L: 7,510 mm · *L: 7,513 mm
B: 2,500 mm · G: 1,600 kg

560 WLU

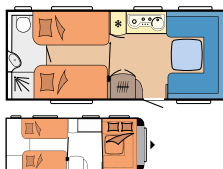

Prestige
L: 7,513 mm · B: 2,500 mm · G: 1,600 kg

560 UL



Premium
L: 8,016 mm · B: 2,500 mm · G: 1,800 kg

620 CL



Prestige
L: 8,025 mm · B: 2,500 mm · G: 1,900 kg

720 WLC



Prestige
L: 9,042 mm · B: 2,500 mm · G: 2,200 kg

CHILDREN'S BEDS

470 KMF

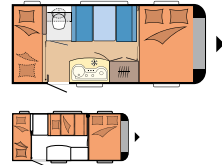

Ontour
L: 6,706 mm · B: 2,200 mm · G: 1,350 kg

490 KMF

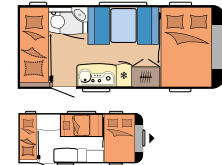

De Luxe, De Luxe Edition
L: 6,885 mm · B: 2,300 mm · G: 1,400 kg

540 KMFe

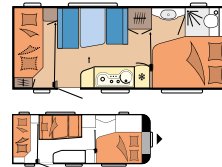

De Luxe
L: 7,442 mm · B: 2,300 mm · G: 1,600 kg

545 KMF

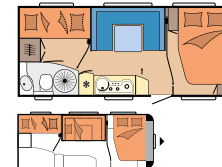

De Luxe, De Luxe Edition
L: 7,422 mm · B: 2,500 mm · G: 1,600 kg

650 KMFe

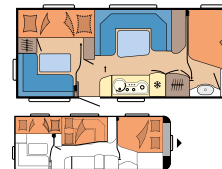

De Luxe Edition
L: 8,322 mm · B: 2,500 mm · G: 1,900 kg

650 KFU

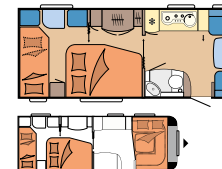

Prestige
L: 8,375 mm · B: 2,500 mm · G: 1,900 kg

720 UKFe



Prestige
L: 9,030 mm · B: 2,500 mm · G: 2,200 kg

720 KWFU



Prestige
L: 9,042 mm · B: 2,500 mm · G: 2,200 kg

515 UHK

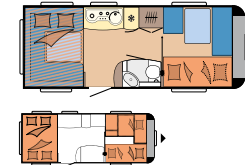

De Luxe
L: 7,530 mm · B: 2,300 mm · G: 1,600 kg

560 KMFe

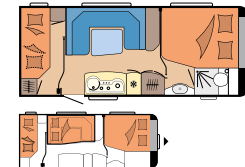

De Luxe, De Luxe Edition, Excellent
L: 7,510 mm · B: 2,500 mm · G: 1,700 kg

650 UKFe

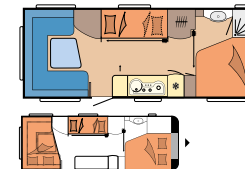

Premium
L: 8,879 mm · B: 2,500 mm · G: 2,000 kg



MADE IN GERMANY

GERMANY

Hobby-Wohnwagenwerk
Ing. Harald Striewski GmbH
Harald-Striewski-Straße 15
24787 Fockbek/Rendsburg
www.hobby-caravaning.de
www.facebook.com/hobby.de

WORLDWIDE

Austria · Belgium · Bulgaria · Chile · China
Czech Republic · Denmark · Estonia · Finland
France · Germany · Greece · Hungary
Iceland · Ireland · Israel · Italy · Japan
Mongolia · Netherlands · New Zealand · Norway
Poland · Portugal · Republic of Korea · Romania
Slovenia · Spain · Sri Lanka · Sweden
Switzerland · Thailand · United Kingdom

GENERAL INFORMATION

Caravan catalogue for the 2019 season
Last updated August 2018

Some of the models featured in the brochure have optional extras or decorations that are not part of the standard scope of delivery. Deviations from the pictured furnishings in terms of structure and colour are excepted provided they relate to the nature of the materials used and are consistent with standard commercial practice. The same applies to technical modifications to the vehicle provided the overall product quality remains the same or is improved and the intended purpose is not impaired.

YOUR DEALER

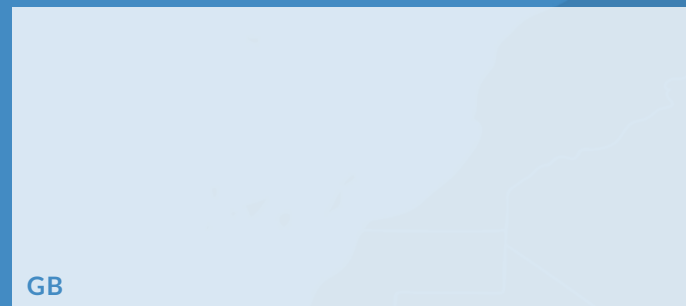

Hobby
BUILT FOR LIFE